

Isolation Voltage	V_{iso}	5000	Vrms
Operating Temperature	T_{opr}	-40~110	
Junction Temperature	T_j	125	
Storage Temperature	T_{stg}	-40~125	
Soldering Temperature	T_{sol}	260	
Peak pulse voltage ($T_j=25$; non-repetitive,off-state)	V_{pp}	3	kV

NOTE1:

NOTE2:

ELECTRICAL CHARACTERISTICS (Temperature=25°C)

ORDERING INFORMATION

J OC S R 2 3 B M -D6P/S /
JieJie Microelectronics Co., Ltd.

Characteristics Curves

FIG.1: Max. Allowable LED Forward Current vs. Ambient Temperature

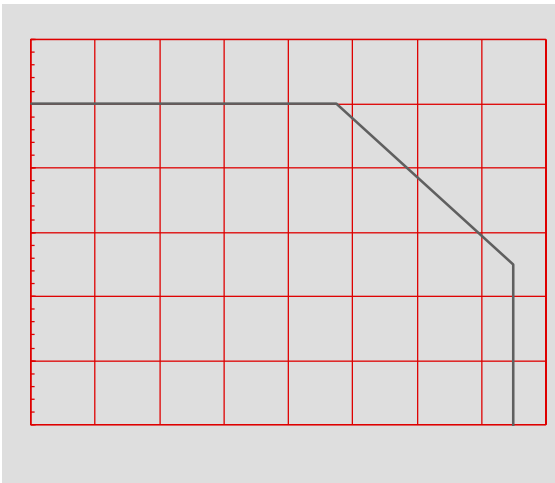
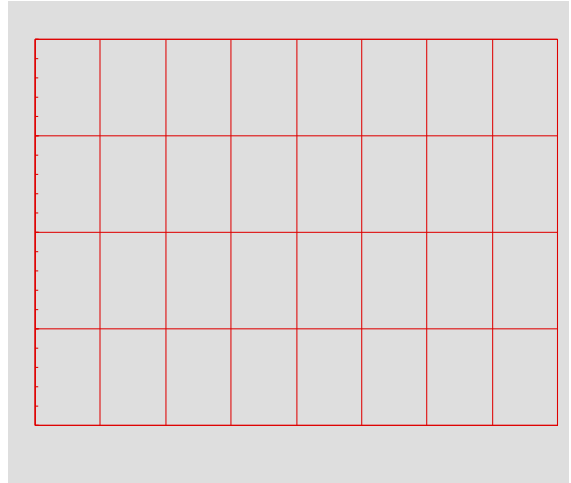

FIG.2: On-state Terminal Current vs. Ambient Temperature



TEST CIRCUITS

FIG.10: Test Circuits of Turn On Time

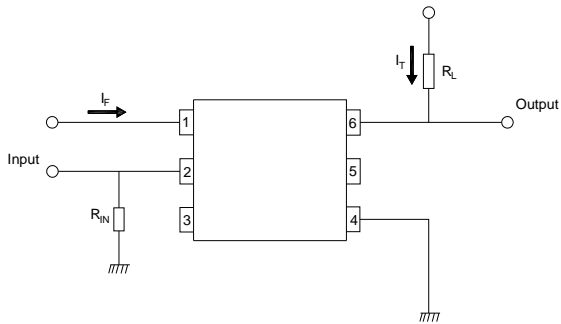
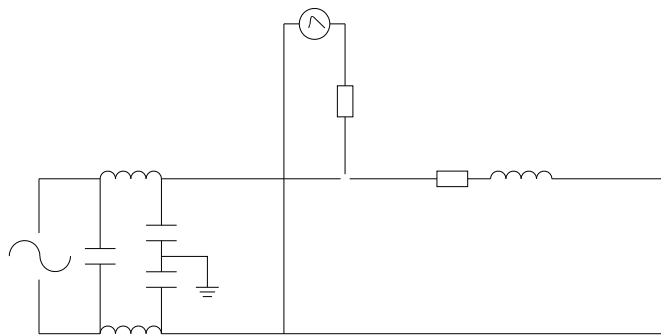

FIG.11: Waveforms of Turn On Time

FIG.12: Test circuit for inductive and resistive loads to IEC-61000-4-5 standards



Package Dimension (Unit: mm)

Standard DIP Type:

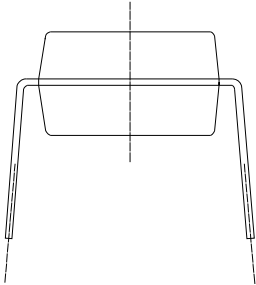
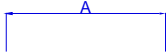

R23

RECOMMENDED SOLDER MASK (Dimensions in mm unless otherwise stated)

Option S1

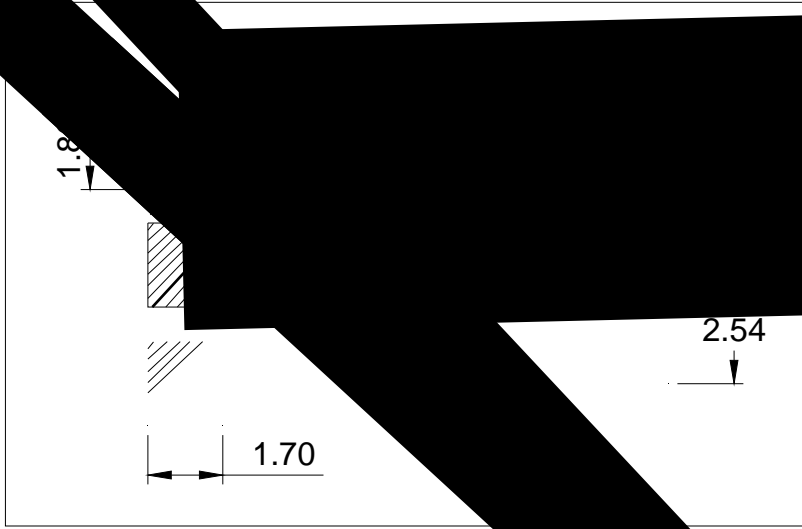

CARRIER TAPE SPECIFICATIONS (Dimensions in mm unless otherwise stated)

Option S/L

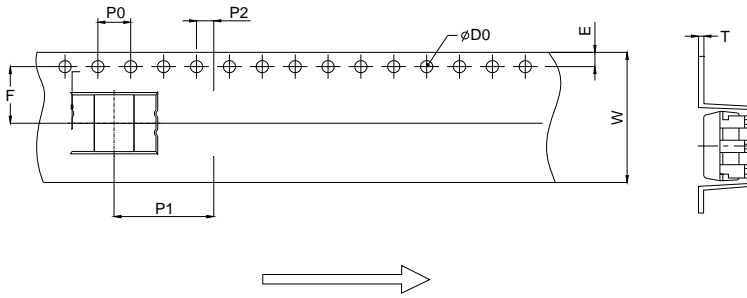

Ref.	Dimensions					
	Millimeters			Inches		
	Min.	Typ.	Max.	Min.	Typ.	Max.
D0		1.50	1.60	0.059	0.063	
P0	3.90	4.00	4.10	0.154	0.157	0.161
P1	11.90	12.00	12.10	0.469	0.472	0.476
P2	1.90	2.00	2.10	0.075	0.079	0.083
E	1.65	1.75	1.85	0.065	0.069	0.073
F	7.40	7.50	7.60	0.291	0.295	0.299
T	0.35	0.40	0.45	0.014	0.016	0.018
W	15.70	16.00	16.30	0.618	0.630	0.642

REFLOW INFORMATION

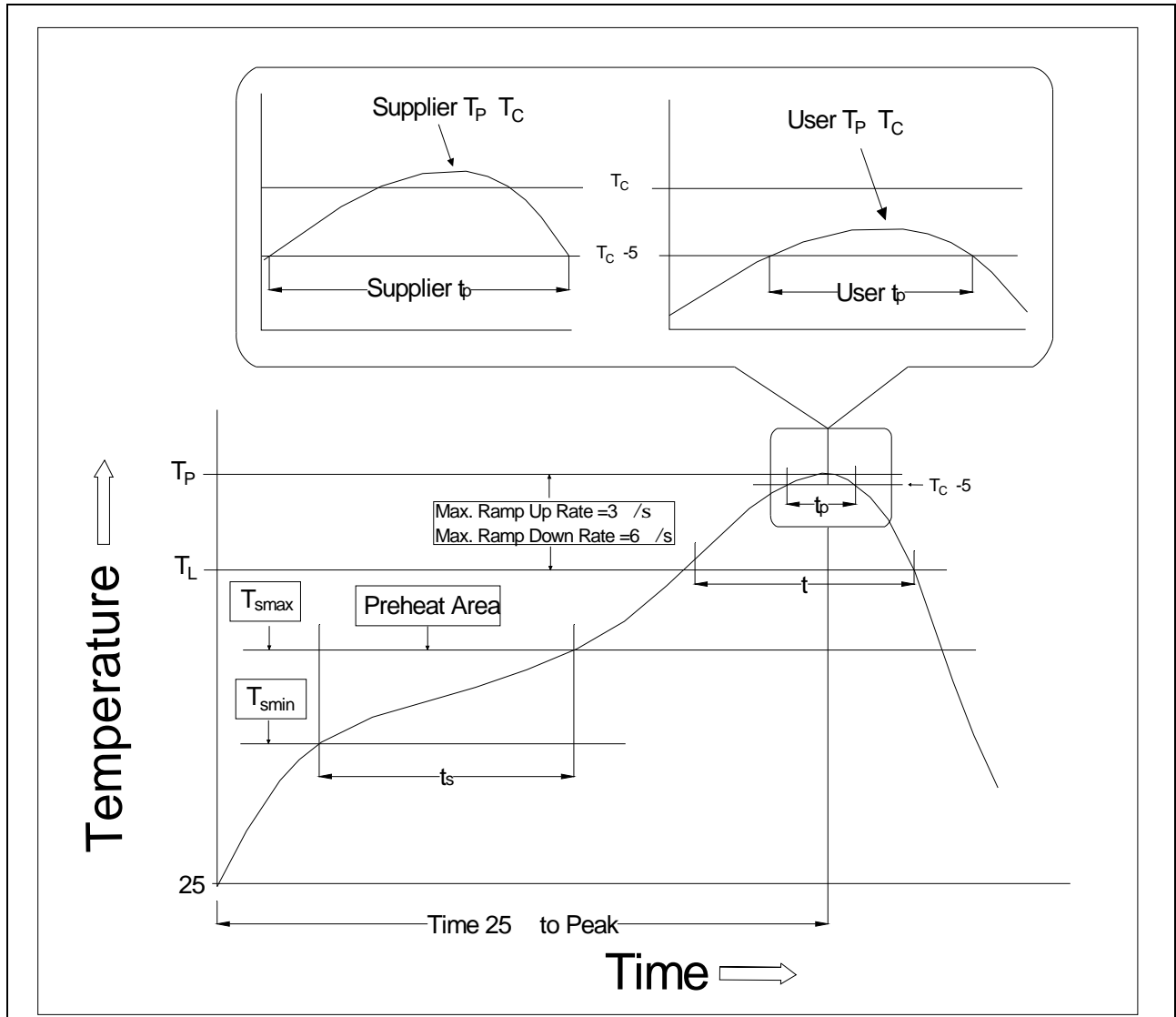

Temperature Min. (T _{smin})	150
Temperature Max. (T _{smax})	200
Time (t _s) from (T _{smin} to T _{smax})	60-120 seconds
Ramp-up Rate (t _L to t _P)	3 /second max.
Liquidus Temperature (T _L)	217
Time (t _L) Maintained Above (T _L)	60-120 seconds
Peak Body Package Temperature	260 +0 /-5
Time (t _P) within 5 of 260	10 seconds
Ramp-down Rate (T _P to T _L)	6 /second max.

WAVE SOLDERING

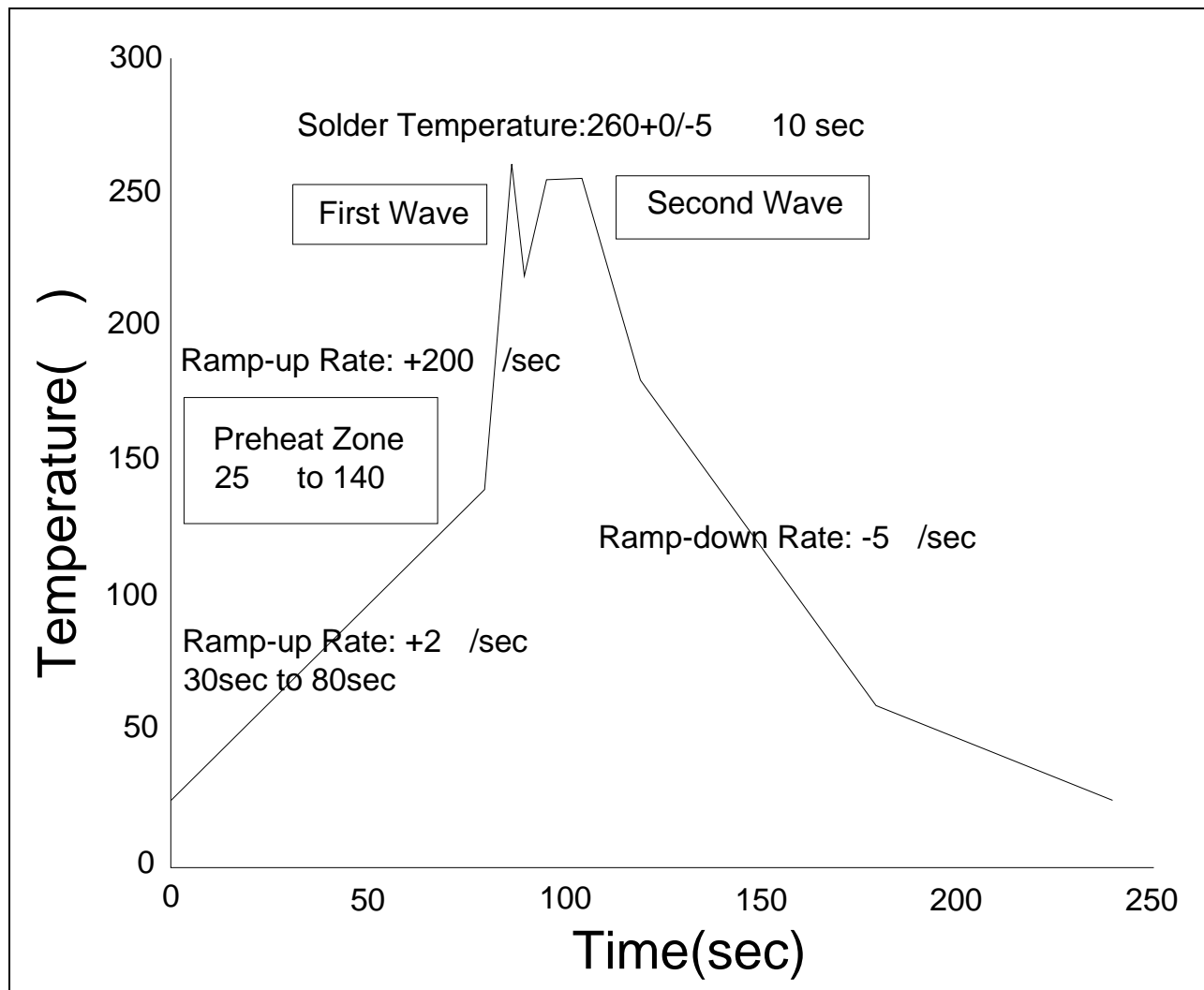

HAND SOLDERING BY SOLDERING IRON

Soldering Temperature	360± 5
Soldering Time	3s max.

Note:

1. Reflow soldering is recommended at the temperatures and times shown, no more than three times.
2. Avoid direct contact between the epoxy body and any tools or surfaces exceeding its maximum storage temperature.
3. Application of pressure on the epoxy body is prohibited at elevated temperatures. In specific scenarios, any applied force must not exceed 2.5N.
4. Ensure the component has cooled to ambient temperature before proceeding with any subsequent manufacturing steps.
5. The component has a shelf life of one year when stored under standard conditions.
6. Recommend storage Temp.: 0~40°C;
Recommend storage humidity: <60%;
MSL level: MSL 1

Information furnished in this document is believed to be accurate and reliable. However, Jiangsu JieJie Microelectronics Co., Ltd. does not assume any responsibility for errors or omissions, or for damages of any kind arising from the use of the information contained herein.